



300-175^{Q&As}

Cisco Data Center Unified Computing





Pass Cisco 300-175 Exam with 100% Guarantee

Free Download Real Questions & Answers **PDF** and **VCE** file from:

<https://www.geekcert.com/300-175.html>

100% Passing Guarantee
100% Money Back Assurance

Following Questions and Answers are all new published by Cisco
Official Exam Center

-  **Instant Download** After Purchase
-  **100% Money Back** Guarantee
-  **365 Days** Free Update
-  **800,000+** Satisfied Customers





QUESTION 1

Which two protocols enable you to download a firmware image from a remote location to a Cisco UCS Fabric Interconnect? (Choose two)

- A. HTTPS
- B. HTTP
- C. RDP
- D. SCP
- E. TFTP

Correct Answer: DE

Reference: https://www.cisco.com/c/en/us/td/docs/unified_computing/ucs/sw/firmware-mgmt/cli/2-2/b_CLI_Firmware_Management_22/downloading_and_managing_firmware_in_cisco_ucs_manager.pdf

QUESTION 2

Which two policy resolution control options are available when registering a Cisco UCS domain in UCS Manager and UCS Central? (Choose Two)

- A. Global
- B. Universal
- C. Server
- D. Local
- E. Host

Correct Answer: AD

Reference: https://www.cisco.com/c/en/us/td/docs/unified_computing/ucs/ucs-central/deployment-guide/1-0/b_UCSC_Deployment_Guide_10/b_UCSC_Deployment_Guide_10_chapter_0100.pdf

QUESTION 3

Scenario

In this scenario, you will refer to screenshots about Cisco UCS B-Series servers and UCS Manager.

Instructions

To access the multiple-choice questions, click on the numbered boxes on the left of the top panel. There are four multiple-choice questions with this task. Be sure to answer all four questions before selecting the Next button.



DCUCI 5.0 Lab Topology—Backbone

Legend:

- Fibre Channel
- 10 GE with FCoE
- - - 10 GE
- 1 GE
- GE = Gigabit Ethernet

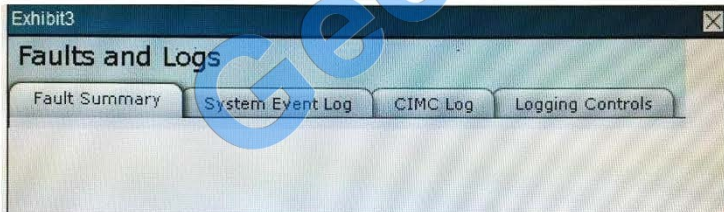
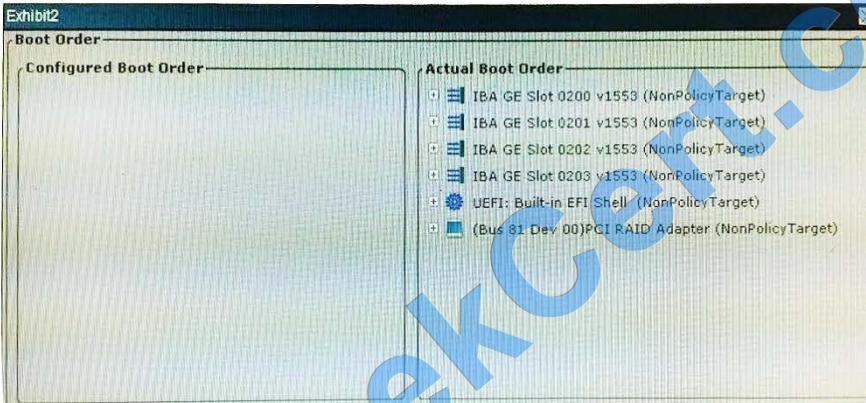
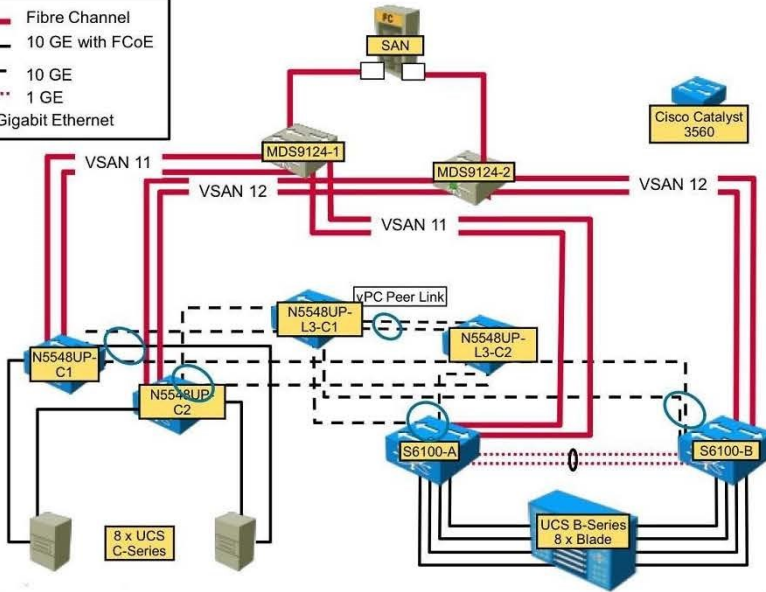



Exhibit4

Trap Details

Trap Settings

ID: 1

Enabled:

SNMP Version: V3

Trap Type: Trap Inform

User: None

Destination IP: 0.0.0.0

OK Reset Values Close

Exhibit5

User Details

User Properties

ID: 2

Enabled:

Username: _____

Role: read-only

Change Password:

New Password: _____

Confirm New Password: _____

Save Changes Reset Values Cancel



Refer to the screenshot in Exhibit 4. Once you enable an SNMP Trap destination, which SNMP Version is required to configure the Inform Trap Type?

- A. 1
- B. 2
- C. 2c
- D. 3

Correct Answer: D

http://www.cisco.com/c/en/us/td/docs/switches/datacenter/sw/5_x/nx-os/system_management/configuration/guide/sm_nx_os_cg/sm_9snmp.html

QUESTION 4

Which three components are parts of the Cisco UCS -Series Blade Server software bundle? (Choose three.)

- A. the adapter firmware
- B. the Kernel and system firmware for fabric interconnects
- C. the BIOS firmware
- D. the IOM firmware
- E. the Cisco UCS Manager software
- F. the board controller firmware

Correct Answer: ACF

http://www.cisco.com/c/en/us/td/docs/unified_computing/ucs/sw/firmware-mgmt/gui/2-2/b_GUI_Firmware_Management_22/b_GUI_Firmware_Management_22_chapter_0100.html

QUESTION 5

Which boot option is recommended for a boot policy because it offers the most service profile mobility within a system?

- A. iSCSI boot
- B. local disk boot
- C. LAN boot
- D. SAN boot

Correct Answer: D



VCE & PDF

GeekCert.com

<https://www.geekcert.com/300-175.html>

2021 Latest geekcert 300-175 PDF and VCE dumps Download

[Latest 300-175 Dumps](#)

[300-175 Study Guide](#)

[300-175 Braindumps](#)



To Read the [Whole Q&As](#), please purchase the [Complete Version](#) from [Our website](#).

Try our product !

- 100% Guaranteed Success
- 100% Money Back Guarantee
- 365 Days Free Update
- Instant Download After Purchase
- 24x7 Customer Support
- Average 99.9% Success Rate
- More than 800,000 Satisfied Customers Worldwide
- Multi-Platform capabilities - [Windows](#), [Mac](#), [Android](#), [iPhone](#), [iPod](#), [iPad](#), [Kindle](#)

We provide exam PDF and VCE of Cisco, Microsoft, IBM, CompTIA, Oracle and other IT Certifications. You can view Vendor list of All Certification Exams offered:

<https://www.geekcert.com/allproducts>

Need Help

Please provide as much detail as possible so we can best assist you.
To update a previously submitted ticket:

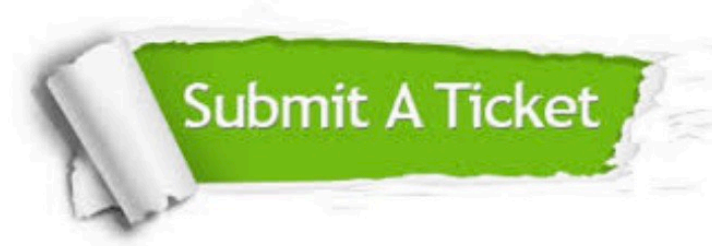

 <p>One Year Free Update Free update is available within One Year after your purchase. After One Year, you will get 50% discounts for updating. And we are proud to boast a 24/7 efficient Customer Support system via Email.</p>	 <p>Money Back Guarantee To ensure that you are spending on quality products, we provide 100% money back guarantee for 30 days from the date of purchase.</p>	 <p>Security & Privacy We respect customer privacy. We use McAfee's security service to provide you with utmost security for your personal information & peace of mind.</p>
---	---	--

Any charges made through this site will appear as Global Simulators Limited.
All trademarks are the property of their respective owners.
Copyright © geekcert, All Rights Reserved.