



# HP2-T25<sup>Q&As</sup>

Servicing HP Rack-Tower Server Solutions

**Pass HP HP2-T25 Exam with 100% Guarantee**

Free Download Real Questions & Answers **PDF** and **VCE** file from:

<https://www.geekcert.com/HP2-T25.html>

100% Passing Guarantee  
100% Money Back Assurance

Following Questions and Answers are all new published by HP Official Exam Center

-  **Instant Download** After Purchase
-  **100% Money Back** Guarantee
-  **365 Days** Free Update
-  **800,000+** Satisfied Customers





## QUESTION 1

What is the best way to exercise replaced DAS components in a server?

- A. Run HP Insight Diagnostics online, selecting Diagnose.
- B. Run ADU.
- C. Run the hard disk test in BIOS.
- D. Run HP Insight Diagnostics offline, selecting Custom Test.

Correct Answer: D

\* (not A) Using the Test tab (HP Insight Diagnostics Offline Edition only) \*

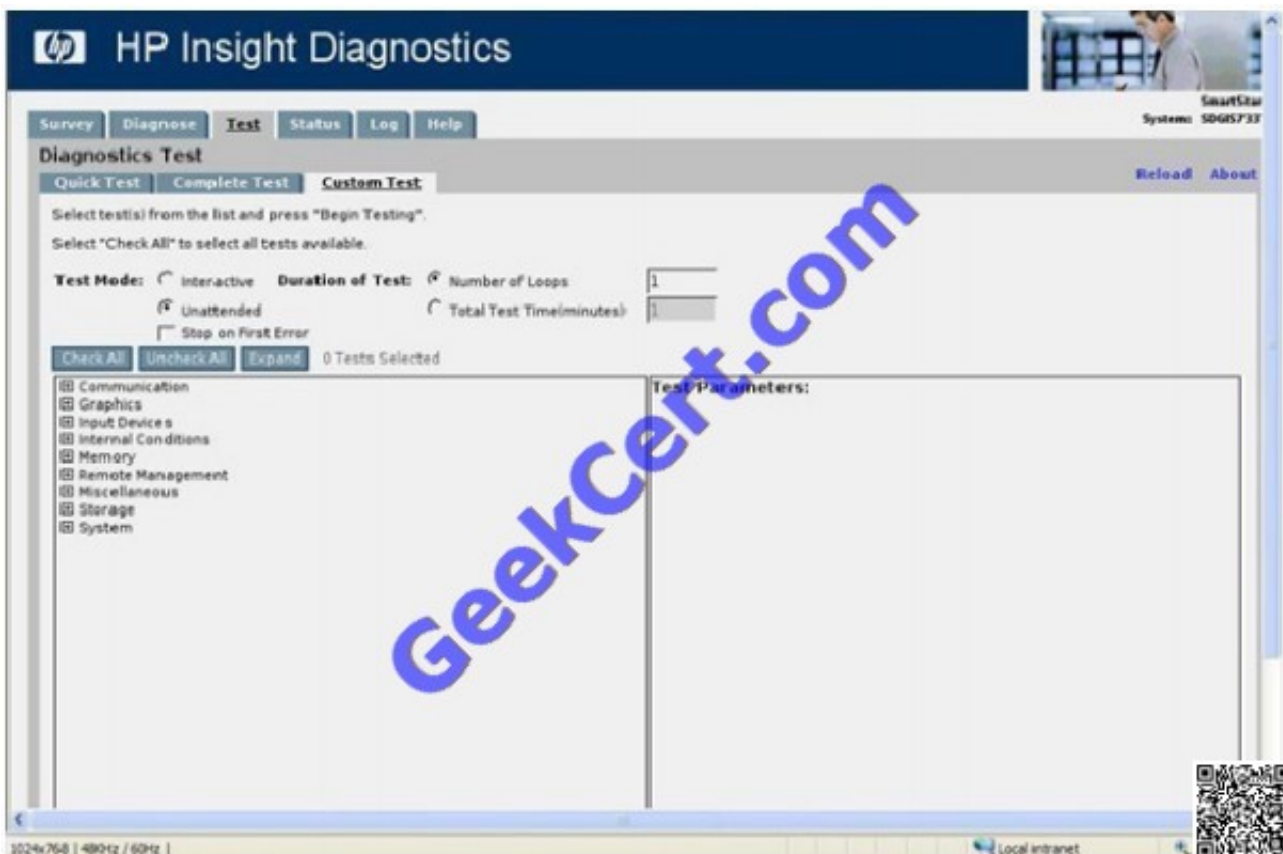

Note: direct attached storage (DAS) References:

## QUESTION 2

A support engineer is attending a call out for a DL360P Gen8 Server, where a hard disk within a four disk RAID 5 set has failed. The engineer notices that on three of the drives, the LED labeled D on the exhibit is on.

What does the condition indicate?

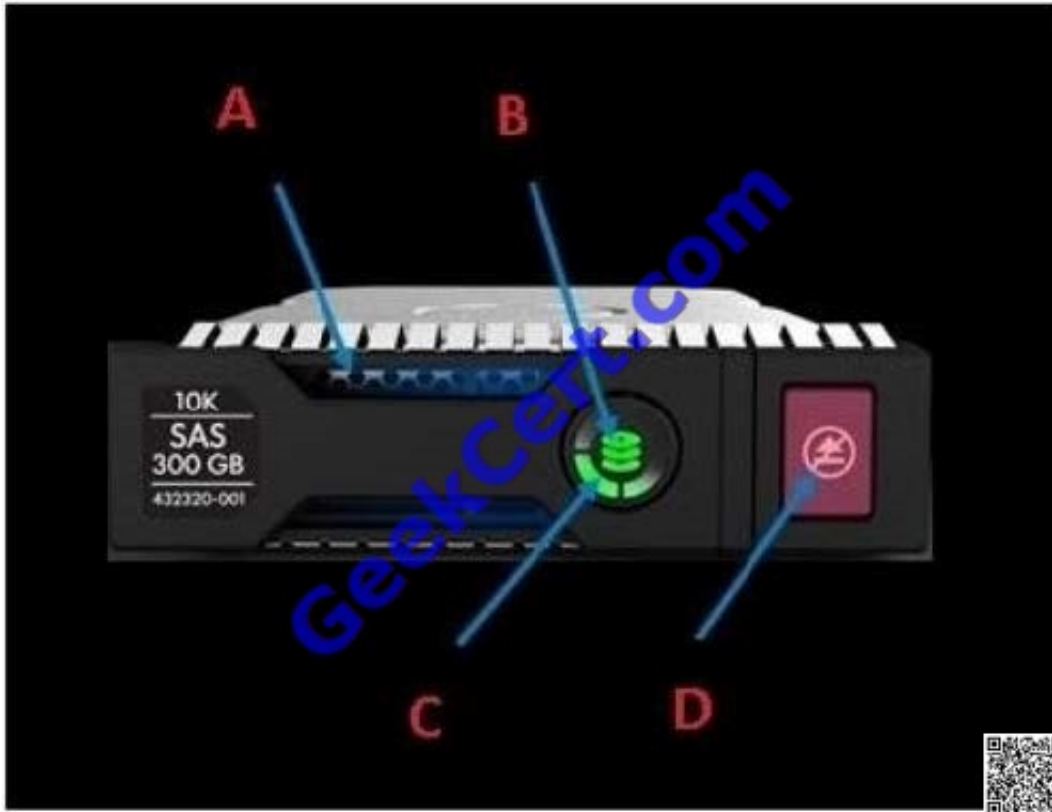

A. Hot swapping of the failed drive is not supported in this condition.

B. The LED indicates both failure and predictive failure alerts; therefore, two additional drives in the RAID set are at risk of failing and need to be replaced.

C. The drive failure has corrupted three drives in the RAID set. The array will need to be rebuilt and data restored from backup.

D. Do not remove the drives with this LED on.

Correct Answer: D

Drive LED definitions

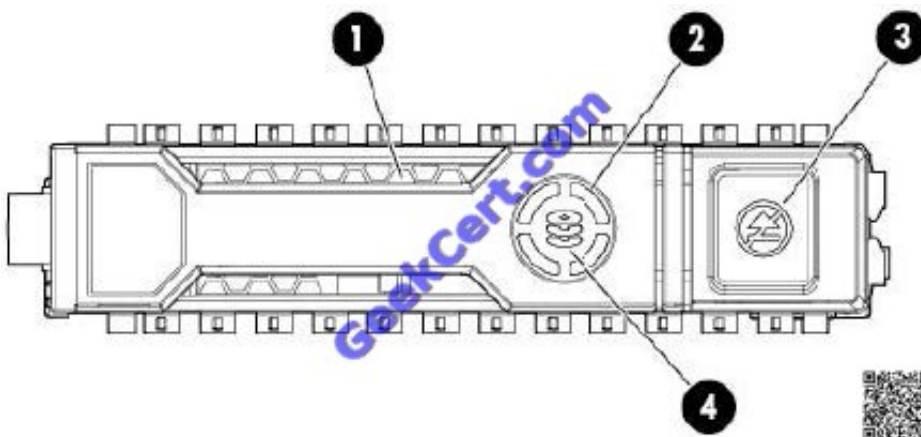

\* Do not remove / Solid white Do not remove the drive. Removing the drive causes one or more of the logical drives to



fail. / Off Removing the drive does not cause a logical drive to fail.

---

### QUESTION 3

Match the correct UPS description with each picture.

Hot Area:

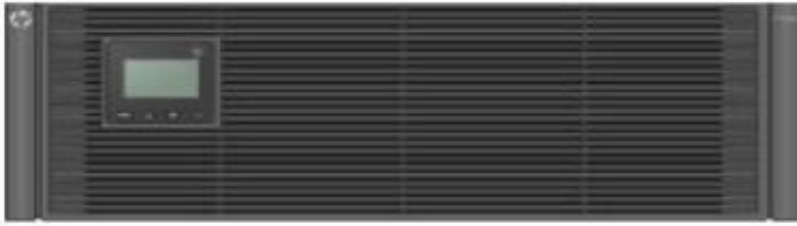

R7000
RP36000/3
R8000/3
R/T2200 G2
R1500 G3
R5500
T1000 G3



R7000
RP36000/3
R8000/3
R/T2200 G2
R1500 G3
R5500
T1000 G3



R7000
RP36000/3
R8000/3
R/T2200 G2
R1500 G3
R5500
T1000 G3



R7000
RP36000/3
R8000/3
R/T2200 G2
R1500 G3
R5500
T1000 G3



Hot Area:



R7000
RP36000/3
R8000/3
R/T2200 G2
R1500 G3
R5500
T1000 G3



R7000
RP36000/3
R8000/3
R/T2200 G2
R1500 G3
R5500
T1000 G3



R7000
RP36000/3
R8000/3
R/T2200 G2
R1500 G3
R5500
T1000 G3

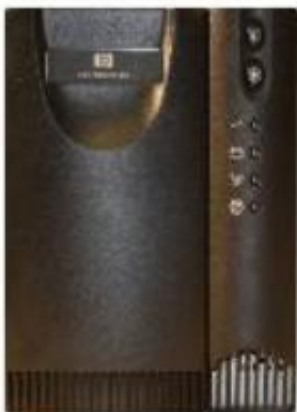

R7000
RP36000/3
R8000/3
R/T2200 G2
R1500 G3
R5500
T1000 G3



Correct Answer:





R7000
RP36000/3
R8000/3
R/T2200 G2
R1500 G3
R5500
T1000 G3



R7000
RP36000/3
R8000/3
R/T2200 G2
R1500 G3
R5500
T1000 G3



R7000
RP36000/3
R8000/3
R/T2200 G2
R1500 G3
R5500
T1000 G3

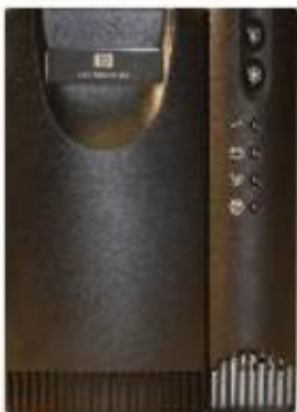

R7000
RP36000/3
R8000/3
R/T2200 G2
R1500 G3
R5500
T1000 G3

www.GeekCert.com



#### QUESTION 4

What is the first step when creating a NIC team using NCU?

- A. Select team members.
- B. Configure the team IP address.
- C. Set IP of each NIC to be used in the team.
- D. Choose team type.

Correct Answer: A

1.

The HP Network Configuration Utility Properties window will look like the one provided below.

2.

Select 2 NICs by clicking on it and then click Team button.

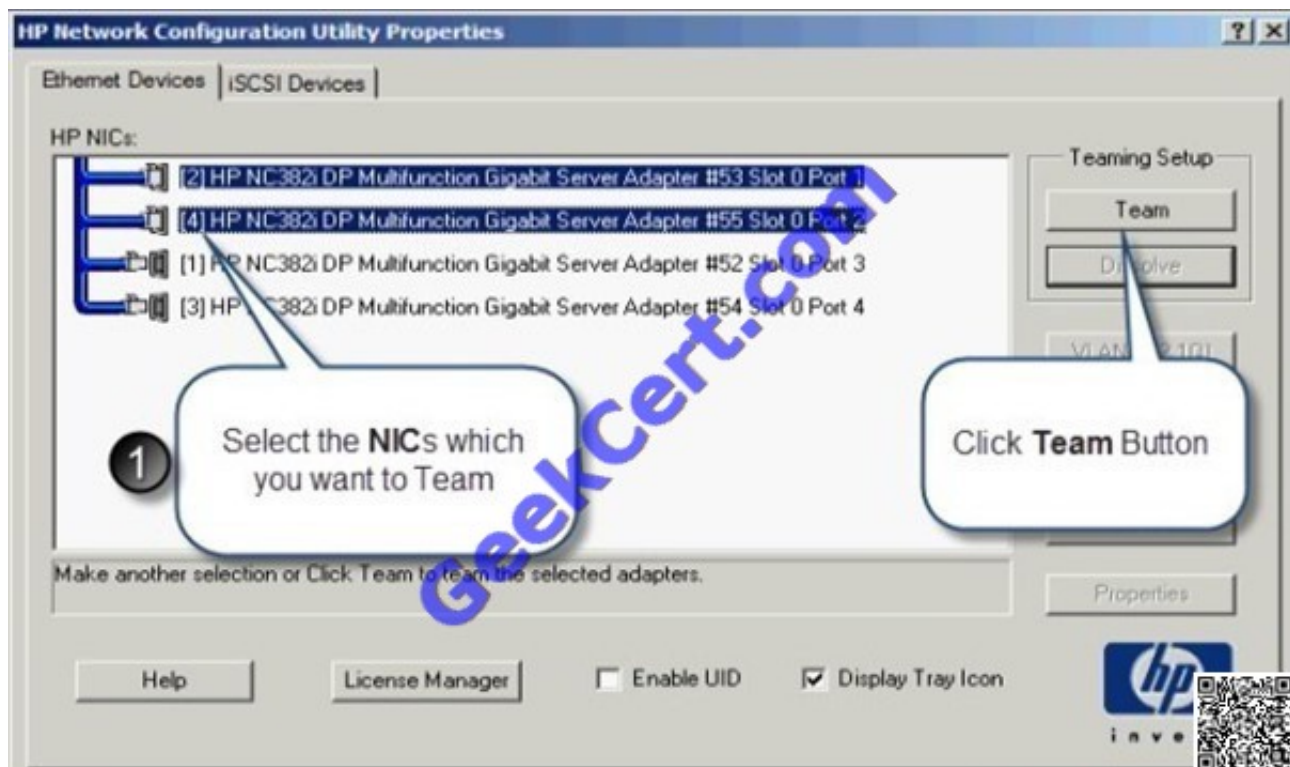

Note:

\*

NIC Teaming (Network Teaming) means you are grouping two or more physical NICs and it will act as a single NIC. You may call it as a Virtual NIC. Minimum number of NICs which can be grouped (Teamed) is Two and the maximum



number of NICs which you can group is Eight.

\*

To create NIC Teaming in Windows 2008/2003 Operating System, we need to use the HP Network Configuration Utility (NCU).

---

#### QUESTION 5

A customer has an HP Integrity rx2800 i2 server with one processor and two memory risers, each with four DIMMs. The customer added an additional memory riser with four memory DIMMs, but cannot see the additional memory at the operating system level. The customer already swapped the first memory riser with the new one, but there is no change.

What could cause this issue?

- A. One of the new DIMMs is faulty.
- B. The new memory riser is faulty.
- C. An additional license is needed for using more than two memory risers.
- D. An additional processor is needed for using more than two memory risers.

Correct Answer: C

\*The DIMMs are partitioned by the number of processors installed in the server. If you have only one processor installed in the system, you can only use 12 of the 24 memory slots. \*



Table 10 Memory Load Order

Pair number	2 Processor system (socket 0 and 1)		1 Processor system (socket 0)	
	Memory expansion board	Memory slots	Memory expansion board	Memory slots
1	Memory expansion board 1	3A and 4A	Memory expansion board 1	3A and 4A
2	Memory expansion board 3	3A and 4A	Memory expansion board 2	3A and 4A
3	Memory expansion board 2	3A and 4A	Memory expansion board 1	1B and 6B
4	Memory expansion board 4	3A and 4A	Memory expansion board 2	1B and 6B
5	Memory expansion board 1	1B and 6B	Memory expansion board 1	2C and 5C
6	Memory expansion board 3	1B and 6B	Memory expansion board 2	2C and 5C
7	Memory expansion board 2	1B and 6B	—	—
8	Memory expansion board 4	1B and 6B	—	—
9	Memory expansion board 1	2C and 5C	—	—
10	Memory expansion board 3	2C and 5C	—	—



[HP2-T25 PDF Dumps](#)

[HP2-T25 VCE Dumps](#)

[HP2-T25 Brindumps](#)



To Read the [Whole Q&As](#), please purchase the [Complete Version](#) from [Our website](#).

## Try our product !

- 100% Guaranteed Success
- 100% Money Back Guarantee
- 365 Days Free Update
- Instant Download After Purchase
- 24x7 Customer Support
- Average 99.9% Success Rate
- More than 800,000 Satisfied Customers Worldwide
- Multi-Platform capabilities - [Windows](#), [Mac](#), [Android](#), [iPhone](#), [iPod](#), [iPad](#), [Kindle](#)

We provide exam PDF and VCE of Cisco, Microsoft, IBM, CompTIA, Oracle and other IT Certifications. You can view Vendor list of All Certification Exams offered:

<https://www.geekcert.com/allproducts>

## Need Help

Please provide as much detail as possible so we can best assist you.  
To update a previously submitted ticket:



 <b>One Year Free Update</b> <p>Free update is available within One Year after your purchase. After One Year, you will get 50% discounts for updating. And we are proud to boast a 24/7 efficient Customer Support system via Email.</p>	 <b>Money Back Guarantee</b> <p>To ensure that you are spending on quality products, we provide 100% money back guarantee for 30 days from the date of purchase.</p>	 <b>Security &amp; Privacy</b> <p>We respect customer privacy. We use McAfee's security service to provide you with utmost security for your personal information &amp; peace of mind.</p>
---	---	--

Any charges made through this site will appear as Global Simulators Limited.  
All trademarks are the property of their respective owners.  
Copyright © geekcert, All Rights Reserved.